

つくろう、ならそう！

ぎたー

つくり方

つかうもの

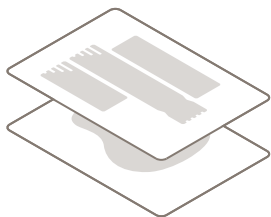

かた紙 (A3)

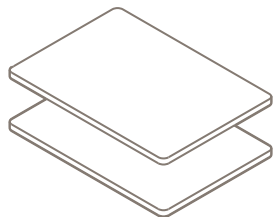

ダンボール (A3)



わゴム



ハサミ / カッター



のり



ボンド

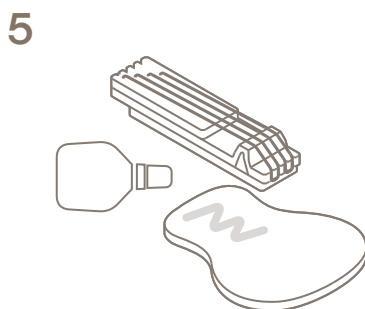
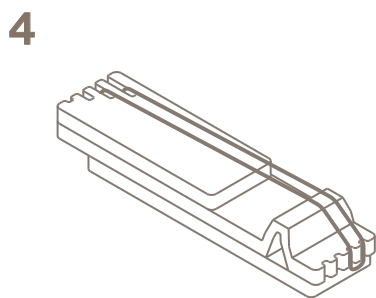
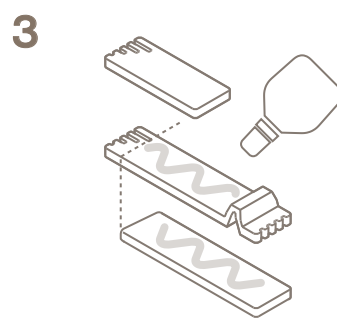
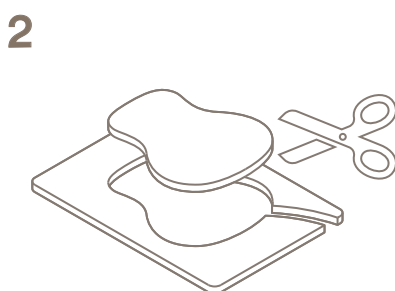
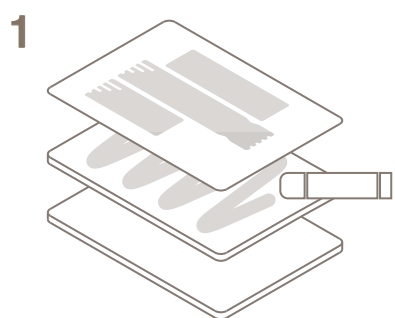

● 小さなお子さまは、大人の方と一緒に作業してください ● ハサミやカッターを使うときは、手を切らないように注意してください